

# SFP6604WSPNR



Product Family	Oven
Category	60cm
Power supply	Electric
Heat source	Electric
Cooking method	Combi Steam
Steam technology	Smart steam 40
SmegConnect	Yes
Cleaning system	Pyrolytic
Oven control	Electronic
EAN code	8017709276096



## Aesthetics

Aesthetics	Dolce Stil Novo	Glass Type	Eclipse
Colour	Black	Door	Full glass
Finishing	Gloss	Handle	Dolce Stil Novo
Design	Flat	Handle Colour	Black
Component finish	Copper	Logo	Applied
Material	Glass		

## Controls













Display name	VivoScreen	No. of display languages	11
Display technology	TFT	Display languages	Italiano, English (UK), Français (FR), Nederlands, Español (ES), Português (PT), Svenska, Русский, Deutsch (DE), Dansk, Polski
Control setting	Touch control		

## Programme / Functions

No. of cooking functions	15
Automatic programmes	53
Steam assisted levels	3
Customisable recipes	64





### Traditional cooking functions

- |  |  |   |
|--|--|---|
|  Static                                    |  Fan assisted |  Circulaire          |
|  Turbo (circulaire + bottom + upper + fan) |  ECO          |  Large grill         |
|  Fan grill (large)                         |  Base         |  Circulaire + bottom |
|  Pizza                                     |  |   |







### Cooking functions with pulsed steam

- |  |  |   |
|--|--|---|
|  Bottom element + Upper element + Fan        |  Circulaire + fan   |  Circulaire + Bottom + Fan |
|  Turbo (circulaire + bottom + upper + fan) |  Half grill + Fan |   |

### Other Steam functions

- |  |  |   |
|--|--|---|
|  Tank cleaning |  Water outlet |  Water input |
|  Descaling     |  |   |

### Other functions

- |  |   |   |
|--|---|---|
|  Keep warm         |  Defrost by time |  Defrost by weight |
|  Plate rack/warmer |  Proving         |  Sabbath           |

### Cleaning functions

-  Pyrolytic

## Options



Timer

Electronic

Smart cooking

Yes

<b>Time-setting options</b>	Delay start and automatic end cooking	<b>Showroom demo option</b>	Yes
<b>Minute minder</b>	Yes	<b>Demo-tutorial mode</b>	Yes
<b>End of cooking acoustic alarm</b>	Yes	<b>Touch guide</b>	Yes
<b>Timer</b>	3	<b>History</b>	Yes, the last 10 functions utilised
<b>Controls Lock / Child Safety</b>	Yes	<b>Rapid pre-heating</b>	Yes
<b>Other options</b>	Keep warm, Eco light, Language setting, Digital clock display, Tones, Tones volume, Brightness	<b>Instant GO</b>	Yes
<b>Cooking with probe thermometer</b>	Yes	<b>Connectivity</b>	WI-FI

## Technical Features



<b>Temperature control</b>	Electronic	<b>Door</b>	Cool
<b>Minimum Temperature</b>	30 °C	<b>Removable door</b>	Yes
<b>Maximum temperature</b>	280 °C	<b>Full glass inner door</b>	Yes
<b>Cavity material</b>	Easy clean enamel	<b>Removable inner door</b>	Yes
<b>No. of shelves</b>	5	<b>Total no. of door glasses</b>	4
<b>Shelves type</b>	Metal racks	<b>No. of thermoreflecting door glasses</b>	3
<b>No. of lights</b>	2	<b>Soft Close hinges</b>	Yes
<b>Light type</b>	Halogen	<b>Safety Thermostat</b>	Yes
<b>User-replaceable light</b>	Yes	<b>Heating suspended when door is opened</b>	Yes
<b>Light power</b>	40 W	<b>Cooling system</b>	Tangential
<b>Light when door is opened</b>	Yes	<b>Cooling duct</b>	Double
<b>Lower heating element power</b>	1200 W	<b>Speed Reduction Cooling System</b>	Yes
<b>Upper heating element - Power</b>	1000 W	<b>Door Lock During Pyrolysis</b>	Yes
<b>Grill element - power</b>	1700 W	<b>Water loading</b>	Fill&Hide, automatic
<b>Large grill - Power</b>	2700 W	<b>Tank capacity</b>	160 ml
<b>Circular heating element - Power</b>	2000 W	<b>Usable cavity space dimensions (HxWxD)</b>	360x460x425 mm
<b>Door opening type</b>	Standard opening		

## Performance / Energy Label



<b>Energy efficiency class</b>	A+	<b>Energy consumption per cycle in fan-forced convection</b>	0.68 kWh
<b>Net volume of the cavity</b>	70 litres	<b>Number of cavities</b>	1
<b>Energy consumption per cycle in conventional mode</b>	1.09 kWh	<b>Energy efficiency index</b>	81 %
<b>GAS - Energy consumption in conventional mode</b>	3.92 MJ	<b>Gross volume</b>	79 l

**GAS - Energy consumption in forced air convection** 2.45 MJ

## Accessories Included

	<b>Enamelled tray (20mm)</b> 1	<b>Chrome shelf with back and side stop</b> 2
	<b>Grill mesh</b> 1	<b>Extra deep enamelled tray (40mm)</b> 1
	<b>Telescopic Guide rails, total Extraction</b> 1	<b>Temperature probe</b> Yes, single point

## Electrical Connection

<b>Voltage</b>	220-240 V	<b>Frequency (Hz)</b>	50/60 Hz
<b>Nominal power (W)</b>	3000 W	<b>Power supply cable length</b>	115 cm
<b>Current</b>	13 A		

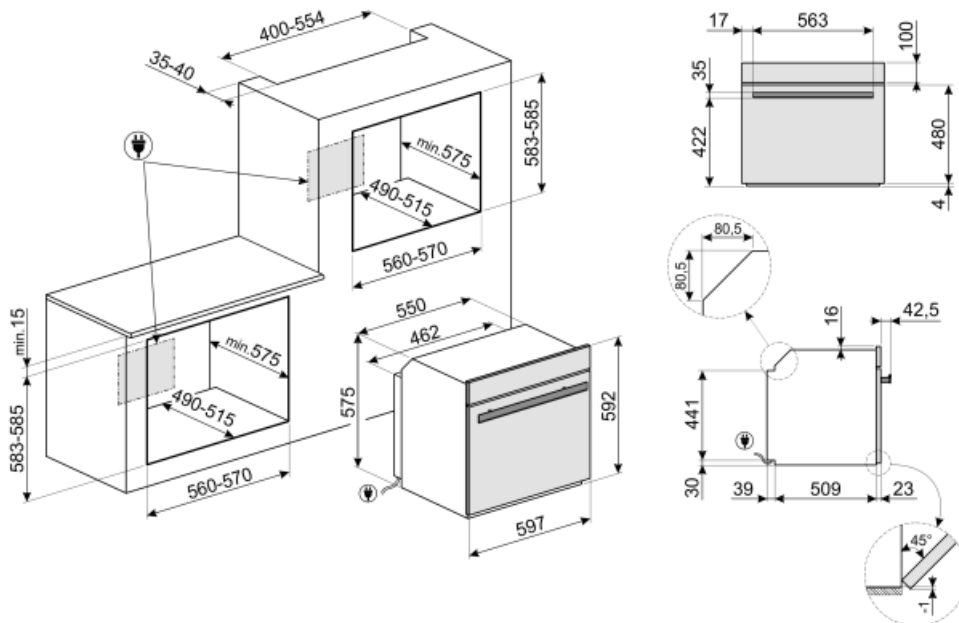

## Not included accessories



### PR3845X

Antifingerprint stainless steel. Cover for furniture in column installation of more ovens



### GT1T-2

Totally extractable telescopic guides (1 level) for ovens with metal frames. Length: 355.5 mm, extraction: 418.5 mm. Material: Stainless steel AISI 430 polished.



### PPR2

Refractory pizza stone without handles. Squared shaped stone: L42 x H1,8 x D37,5 cm. Suitable also for gas ovens, to be put on the griddle.



### PALPZ

Pizza shovel with fold away handle width: 315mm length : 325mm



### BN640

Enamelled tray, 40mm deep



### PR3845N

Black spacer cover for furniture when more ovens are installed in column. Suitable for 45cm Dolce Stil Novo compact ovens.



### GTT

\*\*Totally extractable telescopic guides (1 level)\*\* Extraction: 433 mm Material: Stainless steel AISI 430 polished



### GT1P-2

Partially extractable telescopic guides (1 level) for ovens with metal frames. Length: 355.5 mm, extraction: 285 mm. Material: Stainless steel AISI 430 polished.



### BVG

Glass tray and stainless steel grid, 40mm deep



### PRTX

Refractory pizza stone with handles. D=35cm Not suitable for microwave ovens. Suitable for gas ovens, to be put on the griddle.



### BN620-1

Enamelled tray, 20mm deep



### SFLK1

Child lock

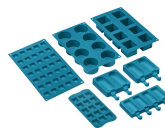

### SMOLD





















Set of 7 silicone moulds for ice creams, ice lollies, pralines, ice cubes or to portion food. Usable from -60°C to +230°C





































### GTP

\*\*Partially extractable telescopic guides (1 level)\*\* Extraction: 300 mm Material: Stainless steel AISI 430 polished

## Symbols glossary

 <p>A+: Energy efficiency class A+ helps to save up to 10% energy compared to class A. Maximum performance with minimum consumption is guaranteed.</p>	 <p>Child lock: some models are fitted with a device to lock the programme/cycle so it cannot be accidentally changed.</p>
 <p>Combination steam: ovens can be used either as a steam oven, or as a traditional oven, or alternatively the two methods can be combined.</p>	 <p>Air cooling system: to ensure a safe surface temperatures.</p>
 <p>Defrost by time: with this function the time of thawing of foods are determined automatically.</p>	 <p>Defrost by weight: With this function the defrosting time is determined</p>
 <p>Descaling function: Is essential to remove excess deposits of limestone in the tank and allow the proper operation of the product. The need to perform this operation is signaled by the product itself.</p>	 <p>...</p>
 <p>Quadruple glazed: Number of glazed doors.</p>	 <p>Automatic lighting switches off: for greater energy savings, the lighting switches off automatically after one minute from the start of cooking.</p>
 <p>Electric</p>	 <p>Enamel interior: The enamel interior of all Smeg ovens have a special antacid lining which helps keep the interior clean by reducing the amount of cooking grease adhering to it.</p>
 <p>Fresh Touch: Most of Smeg ovens have a "cool door." Thanks to the combination of tangential cooling and internal heat-reflecting glasses, the temperature on the outer surface of the door is maintained below 50° C. In addition to providing safety, this system protects the sides of the furniture from overheating by the oven.</p>	 <p>Fan with upper and lower elements: The elements combined with the fan aim to provide more uniform heat, a similar method to conventional cooking, so pre-heat is required. Most suitable for items requiring slow cooking methods.</p>
 <p>Upper and lower element only: a traditional cooking method best suited for single items located in the centre of the oven. the top pf the oven will always be hottest. Ideal for roast, fruit cakes, bread etc.</p>	 <p>Lower heating element only: This function is ideal for foods that require extra base temperature without browning, e.g. pastry dishes, pizza. Also suitable for slow cooking of stews and casseroles.</p>
 <p>Circulaire with lower element: The addition of the lower element adds extra heat at the base for food which requires extra cooking.</p>	 <p>Circulaire: The combination of the fan and circular element around it gives a hot air cooking method. This provides many benefits including no preheat if cook time is more than 20 minutes, no flavour transfer when cooking different foods at the same time, less energy, and shorter cook times. Good for all types of food.</p>
 <p>ECO: The combination of the grill, fan and lower element is particularly suitable for cooking small quantities of food.</p>	 <p>Grill element: Using of grill gives excellent results when cooking meat of medium and small portions, especially when combined with a rotisserie (where possible). Also ideal for cooking sausages and bacon.</p>

- 
- |  |   |
|--|---|
|  <p>Fan with grill element: The fan reduces the fierce heat from the grill, providing an excellent method of grilling various foods, chops, steaks, sausages etc. giving even browning and heat distribution, without drying out the food. The top two levels recommended for use, and the lower part of the oven can be used to keep items warm at the same time, an excellent facility when cooking a grilled breakfast. Half grill (centre portion only) is ideal for small quantities of food.</p> |  <p>Pizza function: The simultaneous operation of three elements ensures an optimum cooking facility when used with the Smeg pizza stone.</p>  |
|  <p>FUN_STEAM_OTHER_WATER_IN_OUT_72dpi</p>   |  <p>Circulaire with upper and lower elements: The use of the fan with both elements allows food to be cooked quickly and effectively, ideal for large joints that require thorough cooking. It offers a similar result to rotisserie, moving the heat around the food, instead of moving the food itself, enabling any size or shape to be cooked.</p> |
|  <p>Fan with grill with steam assist: For creating a perfectly roasted meat joint. The extra moisture keeps the meat juicy and tender, whilst the heat from the turbo function creates the caramelised flavours we know and love.</p>  |  <p>Circulaire with steam assist: Provides extra moisture to food during cooking. Excellent for bread baking. The moisture allows the bread dough to stretch further at the beginning of cooking, creating an aerated and light textured dough. The remaining part of the cooking process allows for the signature crust to form.</p>                  |
|  <p>Circulaire + lower element with steam assist: Ideal for reheating flans and quiches. This function will re-crisp the base, whilst filling will not dry out due to the additional moisture in the cooking cavity.</p>   |  <p>Circulaire with steam assist: Provides extra moisture to food during cooking. Excellent for bread baking. The moisture allows the bread dough to stretch further at the beginning of cooking, creating an aerated and light textured dough. The remaining part of the cooking process allows for the signature crust to form.</p>                |
|  <p>Turbo with steam assist: For creating a perfectly roasted meat joint. The extra moisture keeps the meat juicy and tender, whilst the heat from the turbo function creates the caramelised flavours we know and love.</p>   |  <p>All glass inner door: All glass inner door, a single flat surface which is simple to keep clean.</p>   |
|  <p>The inner door glass: can be removed with a few quick movements for cleaning.</p>  |  <p>KEEP_WARM_72dpi</p>  |
|  <p>Side lights: Two opposing side lights increase visibility inside the oven.</p>   |  <p>Pyrolytic: Pyrolytic cleaning cycles can be selected as necessary to automatically clean the oven interior.</p>  |
|  <p>Warming up: An option for dish warming and keeping the prepared meals hot.</p>   |  <p>Cooking with temperature probe: It is possible to display the temperature detected by the probe and set a target temperature that the dish must reach. When the core of the dish reaches the desired temperature, cooking stops</p>  |
|  <p>Air at 40°C provides the perfect environment for proving yeast type dough mixes. Simply select the function and place dough in the cavity for allotted</p>   |  <p>Rapid preheat: The rapid preheat function can be used to reach the selected temperature in just a few minutes.</p>   |

	<p><b>Sabbath:</b> This function allows you to cook food during the Sabbath, the Holiday of rest in the Jewish religion, respecting the precepts. The oven works</p>		<p><b>Touch guide:</b> By holding down any symbol for 3 seconds you can get information on its function</p>
	<p>The oven cavity has 5 different cooking levels.</p>		<p>A SMART STEAM oven offers 3 levels of steam and 5 STEAM-ASSISTED cooking functions to choose from. The water is loaded into the oven before cooking via an automatic loading tube, and steam is generated externally and introduced directly into the cavity. The oven calculates the exact amount of water required for the desired cooking, up to 160ml, and the steam is automatically introduced into the oven, pulsing on and off during cooking according to the setting.</p>
	<p><b>Smart Cooking System:</b> for the perfect cooking it is simply necessary choosing the kind and the weight of food and the cooking temperature: any other setting will be established automatically.</p>		<p>Appliances with Wi-Fi connectivity. Via SmegConnect App is possible to monitor and remotely control appliances through smartphone and tablet (iOS and Android).</p>
	<p><b>Soft close:</b> all models are equipped with advanced function of smooth closing of the door, which allows the device to close smoothly and quietly.</p>		<p>To guarantee the optimal functioning of the appliance, it is suggested to carry out the tank cleaning roughly once every 2-3 months.</p>
	<p><b>Telescopic rails:</b> allow you to pull out the dish and check it without having to remove it from the oven entirely.</p>		<p><b>Electronic control:</b> Allows you to maintain temperature inside the oven with the precision 2-3 ° C. This enables to cook meals that are very sensitive to temperature changes, such as cakes, souffles, puddings.</p>
	<p><b>Touch controls:</b> Easy to use touch controls allow the appliance to be programmed at the touch of a button.</p>		<p>The capacity indicates the amount of usable space in the oven cavity in litres.</p>
	<p>The capacity indicates the amount of usable space in the oven cavity in litres.</p>		<p>Wi-Fi connectivity</p>
	<p>...</p>		<p>...</p>