

SF4604WMCNR

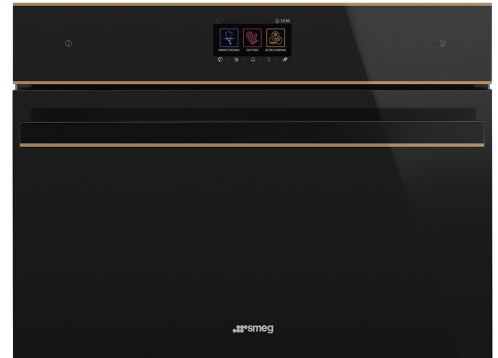

Product Family	Oven
Category	45cm compact
Power supply	Electric
Heat source	Electric
Cooking method	Combi Microwave
SmegConnect	Yes
Cleaning system	Vapor Clean
Oven control	Electronic
EAN code	8017709275976



Aesthetics

Aesthetics	Dolce Stil Novo	Glass Type	Eclipse
Colour	Black	Door	Full glass
Finishing	Gloss	Handle	Dolce Stil Novo
Design	Flat	Handle Colour	Black
Component finish	Copper	Logo	Applied
Material	Glass		

Controls













Display name	VivoScreen	No. of display languages	11
Display technology	TFT	Display languages	Italiano, English (UK), Français (FR), Nederlands, Español (ES), Português (PT), Svenska, Русский, Deutsch (DE), Dansk, Polski
Control setting	Touch control		





Programme / Functions

No. of cooking functions	15
Automatic programmes	56
Customisable recipes	64







Traditional cooking functions

 Static	 Fan assisted	 Circulaire
 Turbo (circulaire + bottom + upper + fan)	 ECO	 Large grill
 Fan grill (large)	 Base	 Circulaire + bottom
 Pizza		

Microwave functions

 Microwave	 Microwave + bottom + top + fan	 Microwave + circulaire + fan
 Microwave + grill	 Warming and re-generation	

Other functions

 Keep warm	 Defrost by time	 Defrost by weight
 Plate rack/warmer	 Proving	 Sabbath

Cleaning functions

 Vapor Clean
--

Options



Timer	Electronic	Showroom demo option	Yes
Time-setting options	Delay start and automatic end cooking	Demo-tutorial mode	Yes
Minute minder	Yes	Touch guide	Yes
End of cooking acoustic alarm	Yes	History	Yes, the last 10 functions utilised
Timer	3	Rapid pre-heating	Yes
Controls Lock / Child Safety	Yes	Instant GO	Yes
		Connectivity	WI-FI

Other options	Keep warm, Eco light, Quick start, Language setting, Tones, Tones volume, Brightness, Eco-logic
Smart cooking	Yes

Technical Features



Temperature control	Electronic	Circular heating element - Power	1400 W
Minimum Temperature	30 °C	Door opening type	Standard opening
Maximum temperature	250 °C	Door	Temperate door
Cavity material	Easy clean enamel	Total no. of door glasses	3
No. of shelves	3	No. of thermoreflecting door glasses	1
Shelves type	Metal racks	Soft Close hinges	Yes
Tilting grill	Yes	Safety Thermostat	Yes
No. of lights	2	Heating suspended when door is opened	Yes
Light type	Halogen	Cooling system	Tangential
Light power	40 W	Cooling duct	Single
Light when door is opened	Yes	Microwave screen protection	Yes
Lower heating element power	1000 W	Microwave stops when door is opened	Yes
Grill element - power	2000 W	Usable cavity space dimensions (HxWxD)	212x462x407 mm

Performance / Energy Label



Net volume of the cavity	40 litres	Gross volume	50 l
Number of cavities	1	Microwave effective power	1000 W

Accessories Included



Grill mesh	1	Telescopic Guide rails, partial Extraction	1
Glass tray	1	Chrome shelf with back and side stop	1

Electrical Connection

Voltage	220-240 V	Frequency (Hz)	50 Hz
Nominal power (W)	3100 W		

Current

14 A

Power supply cable
length

115 cm

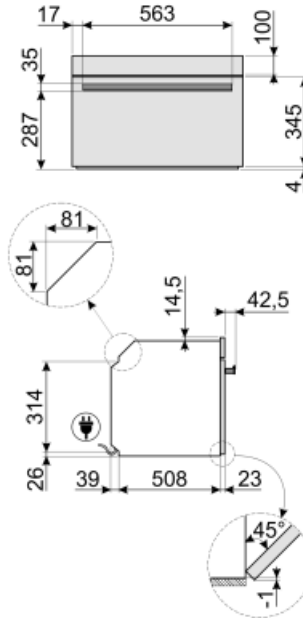
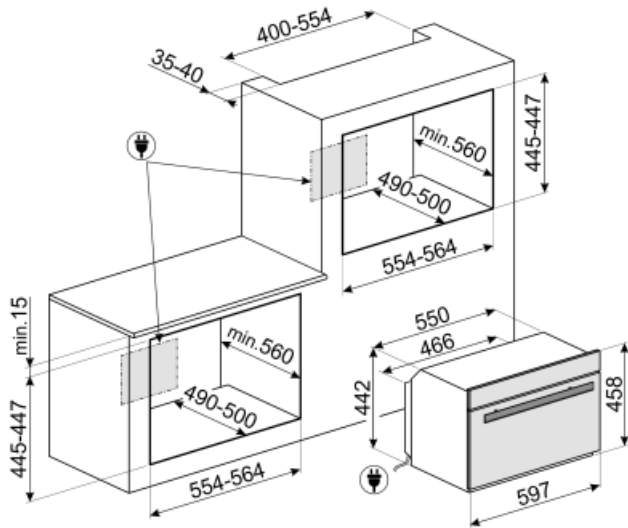

Not included accessories



PR3845X

Antifingerprint stainless steel. Cover for furniture in column installation of more ovens



GT1T-2

Totally extractable telescopic guides (1 level) for ovens with metal frames. Length: 355.5 mm, extraction: 418.5 mm. Material: Stainless steel AISI 430 polished.



PPR2

Refractory pizza stone without handles. Squared shaped stone: L42 x H1,8 x D37,5 cm. Suitable also for gas ovens, to be put on the griddle.



BN620-1

Enamelled tray, 20mm deep



SFLK1

Child lock

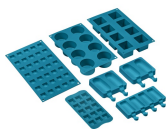

SMOLD

Set of 7 silicone moulds for ice creams, ice lollies, pralines, ice cubes or to portion food. Usable from -60°C to +230°C



GTP

Partially extractable telescopic guides (1 level) Extraction: 300 mm Material: Stainless steel AISI 430 polished



GT1P-2

Partially extractable telescopic guides (1 level) for ovens with metal frames. Length: 355.5 mm, extraction: 285 mm. Material: Stainless steel AISI 430 polished.



BVG

Glass tray and stainless steel grid, 40mm deep



PALPZ

Pizza shovel with fold away handle width: 315mm length : 325mm



BN640

Enamelled tray, 40mm deep



PR3845N



















Black spacer cover for furniture when more ovens are installed in column. Suitable for 45cm Dolce Stil Novo compact ovens.

































GTT

Totally extractable telescopic guides (1 level) Extraction: 433 mm Material: Stainless steel AISI 430 polished

Symbols glossary

 <p>Child lock: some models are fitted with a device to lock the programme/cycle so it cannot be accidentally changed.</p>	 <p>Combination microwave: This oven allows to combine two different ways of cooking (Traditional with microwaves). Combined ovens increase cooking opportunities, while providing maximum flexibility of household appliances.</p>
 <p>Air cooling system: to ensure a safe surface temperatures.</p>	 <p>Defrost by time: with this function the time of thawing of foods are determined automatically.</p>
 <p>Defrost by weight: With this function the defrosting time is determined</p>	 <p>...</p>
 <p>Triple glazed doors: Number of glazed doors.</p>	 <p>Automatic lighting switches off: for greater energy savings, the lighting switches off automatically after one minute from the start of cooking.</p>
 <p>ECO-logic: option allows you to restrict the power limit of the appliance real energy saving.</p>	 <p>Electric</p>
 <p>Enamel interior: The enamel interior of all Smeg ovens have a special antacid lining which helps keep the interior clean by reducing the amount of cooking grease adhering to it.</p>	 <p>Fan with upper and lower elements: The elements combined with the fan aim to provide more uniform heat, a similar method to conventional cooking, so pre-heat is required. Most suitable for items requiring slow cooking methods.</p>
 <p>Upper and lower element only: a traditional cooking method best suited for single items located in the centre of the oven. the top pf the oven will always be hottest. Ideal for roast, fruit cakes, bread etc.</p>	 <p>Lower heating element only: This function is ideal for foods that require extra base temperature without browning, e.g. pastry dishes, pizza. Also suitable for slow cooking of stews and casseroles.</p>
 <p>Circulaire with lower element: The addition of the lower element adds extra heat at the base for food which requires extra cooking.</p>	 <p>Circulaire: The combination of the fan and circular element around it gives a hot air cooking method. This provides many benefits including no preheat if cook time is more than 20 minutes, no flavour transfer when cooking different foods at the same time, less energy, and shorter cook times. Good for all types of food.</p>
 <p>ECO: The combination of the grill, fan and lower element is particularly suitable for cooking small quantities of food.</p>	 <p>Grill element: Using of grill gives excellent results when cooking meat of medium and small portions, especially when combined with a rotisserie (where possible). Also ideal for cooking sausages and bacon.</p>

- | | |
|--|---|
|  <p>Fan with grill element: The fan reduces the fierce heat from the grill, providing an excellent method of grilling various foods, chops, steaks, sausages etc. giving even browning and heat distribution, without drying out the food. The top two levels recommended for use, and the lower part of the oven can be used to keep items warm at the same time, an excellent facility when cooking a grilled breakfast. Half grill (centre portion only) is ideal for small quantities of food.</p> |  <p>Microwave: Penetrating straight into the food, microwaves cook very quickly and with considerable energy savings. Suitable for cooking without fat, they are also able to thaw and heat food without altering its original appearance and aroma. The microwave function can also be combined with conventional functions with all the resulting advantages. Ideal for all types of food.</p> |
|  <p>Cooking with the simultaneous use of the heating element in combination with fan and microwave supply.</p> |  <p>Microwave + grill element: The use of the grill results in a perfect browning of the surface of the food. The action of microwaves allows instead of cooking in a short time the internal part of the food.</p> |
|  <p>Fan combined with traditional cooking, where heat is generated from above and below, provides uniform heat. Adding the microwave function allows the same cooking results in less time.</p> |  <p>This function can reheat precooked dishes, without becoming dry or hard.</p> |
|  <p>Pizza function: The simultaneous operation of three elements ensures an optimum cooking facility when used with the Smeg pizza stone.</p> |  <p>Circulaire with upper and lower elements: The use of the fan with both elements allows food to be cooked quickly and effectively, ideal for large joints that require thorough cooking. It offers a similar result to rotisserie, moving the heat around the food, instead of moving the food itself, enabling any size or shape to be cooked.</p> |
|  <p>Compact appliances with a height of 45 cm - perfect solution to meet the functional requirements of kitchen sets of small height. Available in several types and in different styles.</p> |  <p>KEEP_WARM_72dpi</p> |
|  <p>Side lights: Two opposing side lights increase visibility inside the oven.</p> |  <p>Warming up: An option for dish warming and keeping the prepared meals hot.</p> |
|  <p>Air at 40°C provides the perfect environment for proving yeast type dough mixes. Simply select the function and place dough in the cavity for allotted</p> |  <p>Rapid preheat: The rapid preheat function can be used to reach the selected temperature in just a few minutes.</p> |
|  <p>Sabbath: This function allows you to cook food during the Sabbath, the Holiday of rest in the Jewish religion, respecting the precepts. The oven works</p> |  <p>Touch guide: By holding down any symbol for 3 seconds you can get information on its function</p> |
|  <p>The oven cavity has 3 different cooking levels.</p> |  <p>Smart Cooking System: for the perfect cooking it is simply necessary choosing the kind and the weight of food and the cooking temperature: any other setting will be established automatically.</p> |
|  <p>Appliances with Wi-Fi connectivity. Via SmegConnect App is possible to monitor and remotely control appliances through smartphone and tablet (iOS and Android).</p> |  <p>Soft close: all models are equipped with advanced function of smooth closing of the door, which allows the device to close smoothly and quietly.</p> |

-
- | | | | |
|--|---|---|--|
|  | Telescopic rails: allow you to pull out the dish and check it without having to remove it from the oven entirely. |  | Electronic control: Allows you to maintain temperature inside the oven with the precision 2-3 ° C. This enables to cook meals that are very sensitive to temperature changes, such as cakes, souffles, puddings. |
|  | Tilting grill: the tilting grill can be easily unhooked to move the heating element and clean the roof of the appliance in one simple step. |  | Touch controls: Easy to use touch controls allow the appliance to be programmed at the touch of a button. |
|  | Vapor Clean: a simple cleaning function using steam to loosen deposits in the oven cavity. |  | The capacity indicates the amount of usable space in the oven cavity in litres. |
|  | The capacity indicates the amount of usable space in the oven cavity in litres. |  | Wi-Fi connectivity |
|  | ... |  | ... |