

600 CFM Flexible Blower - Downdraft DHG602DUC

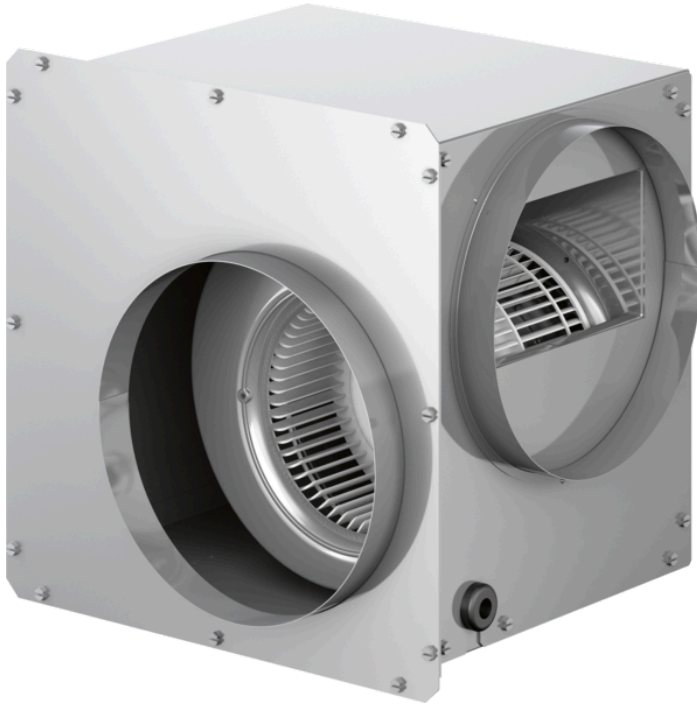

Features and Benefits

Design

- 600 CFM Flexible Blower Has 8" Round Duct Exhaust
- Some Blower Positions May Need Deeper Cabinets. See Installation Guide
- Additional Accessories May Be Required For Installation, See Manual

Performance

- Capable Up To 600 CFM In Performance

Notes: All height, width and depth dimensions are shown in inches. *Please refer to installation instructions prior to making cutout. BSH reserves the absolute and unrestricted right to change product materials and specifications, at any time, without notice. Consult the product's installation instructions for final dimensional data and other details. Applicable product warranty can be found in a accompanying product literature or you may contact your account manager for further details.

For more information on our entire line of products, go to boschappliances.com or call 1-800-944-2904.

Copyright ©2019 BSH Home Appliances Corporation. All rights reserved. Bosch is a registered trademark of Robert Bosch GmbH.

Litho Date: 03/2019

600 CFM Flexible Blower - Downdraft DHG602DUC

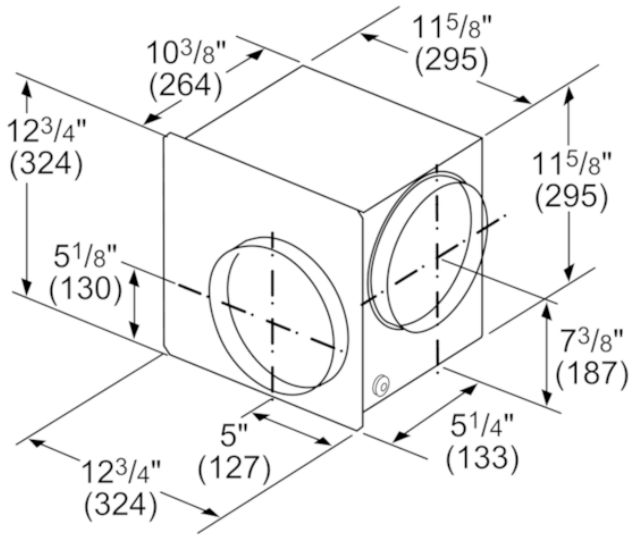

measurements in inches and (mm)

Features

Product Description	
Product group	Accessory
Brand	Bosch
Product name / series name	
SKU	DHG602DUC
Internal article number	00000000000717973
EAN code	4242002916026
Product packaging dimensions (HxWxD) (in)	8 11/16" x 16 9/16" x 17 5/16"
Net weight (lbs)	20
Gross weight (lbs)	22
Quantity per packing unit	
Standard number of units per pallet	30
UPC code	825225921219
Name of product image	MCSA02015201_i2082_1410110_DHG602DUC_d

Technical Specification

Notes: All height, width and depth dimensions are shown in inches. *Please refer to installation instructions prior to making cutout. BSH reserves the absolute and unrestricted right to change product materials and specifications, at any time, without notice. Consult the product's installation instructions for final dimensional data and other details. Applicable product warranty can be found in a accompanying product literature or you may contact your account manager for further details.

For more information on our entire line of products, go to boschappliances.com or call 1-800-944-2904.
Copyright ©2019 BSH Home Appliances Corporation. All rights reserved. Bosch is a registered trademark of Robert Bosch GmbH.

Litho Date: 03/2019