

HMDW36WS

UNDER CABINET DRAWER WALL HOOD WITH BLOWER

(36-INCH WIDTH)

MASTERPIECE® SERIES



FEATURES & BENEFITS

- Pull canopy open for increased capture, or push back for flush design
- ★ - Noise Control Technology™ reduces noise while hood is in use
- ★ - Equipped with the Thermador Connected Experience by Home Connect™
 - Cooktop Hood Sync enables control through Freedom® Induction Cooktop
 - Beautiful illumination with multi-level, vivid LED lights

ACCESSORIES (OPTIONAL)

Recirculation Kit

RECHMDW - For HMDW30WS & HMDW36WS under cabinet drawer hoods only

Replacement Charcoal Filter

CHFHMWB - For use with recirculation kit RECHMDW

Built-In Remote Control Panel

REMCPU - Ability to vertically install on cabinetry or wall to control hood in a convenient location

8" Wall Cap

WC8

GENERAL PROPERTIES

Features

Cooktop Hood-Sync Enabled, Noise Control Technology™, Multi-Level LED Lights with Fading Transitions, Automatic Mode, Check Filter Reminder Light, Delay Shut-Off

Operating Mode	Convertible: Ducted / Recirculating
Maximum CFM	600 CFM
Sones*	1.4
Number of Speed Settings	4-Stage
Motor Location	Integrated
Number Of Lights	2
Bulb Type	LED
Total Power Of The Lamps (W)	2.4
Damper Included	Yes
Grease Filter Material	Washable Stainless Steel
Grease Filter Type	Hybrid Mesh
Home Connect™ (Wi-Fi Enabled)	Yes

TECHNICAL DETAILS

Watts (W)	455 W
Current (A)	15 A
Volts (V)	120 V
Frequency (Hz)	60 HZ
Plug Type	120V-3 Prong

DIMENSIONS & WEIGHT

Overall Appliance Dimensions (Width Of Canopy Included) (HxWxD) (in)	17 9/16" x 35 15/16" x 12" - 19 7/8"
Required Distance Above Cooktop / Range Cooking Surface	30" / 30"
Diameter of Air Duct (in) Top	8"
Net Weight (lbs)	55 lbs

WARRANTY

Limited Warranty Parts And Labor	2 Year
----------------------------------	--------

*Measured on speed 1 in ducted installation

HMDW36WS

UNDER CABINET DRAWER WALL HOOD WITH BLOWER

(36-INCH WIDTH)

MASTERPIECE® SERIES



HOOD DIMENSIONS

*Minimum Cabinet inside height: 24" (610 mm)

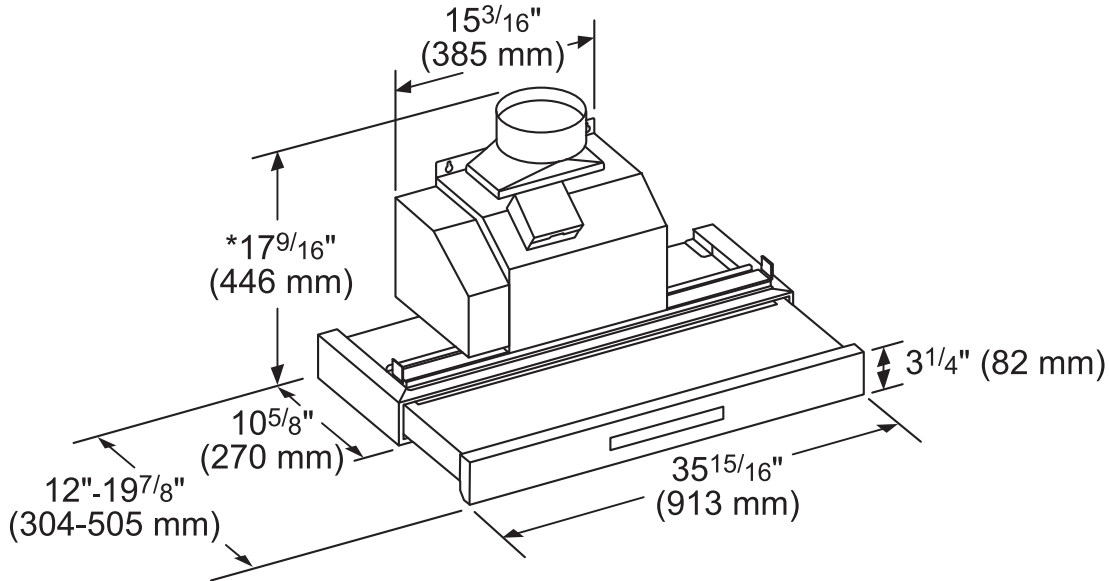

measurements in inches (mm)

OPTIONAL ACCESSORIES

REMOTE CONTROL PANEL REMCPW

Convenience at your fingertips: The remote control accessory offers the freedom to extend your hood controls to a more reachable spot

REPLACEMENT CHARCOAL FILTER

For use with Recirculation Kit RECHMDW

RECIRCULATION KIT RECHMDW

For HMDW30WS & HMDW36WS under cabinet drawer hoods only. Ideal for applications where ducting out is not possible.

HMDW36WS

UNDER CABINET DRAWER WALL HOOD WITH BLOWER

(36-INCH WIDTH)

MASTERPIECE® SERIES



WALL CAPS

8-INCH WALL CAP-WC8

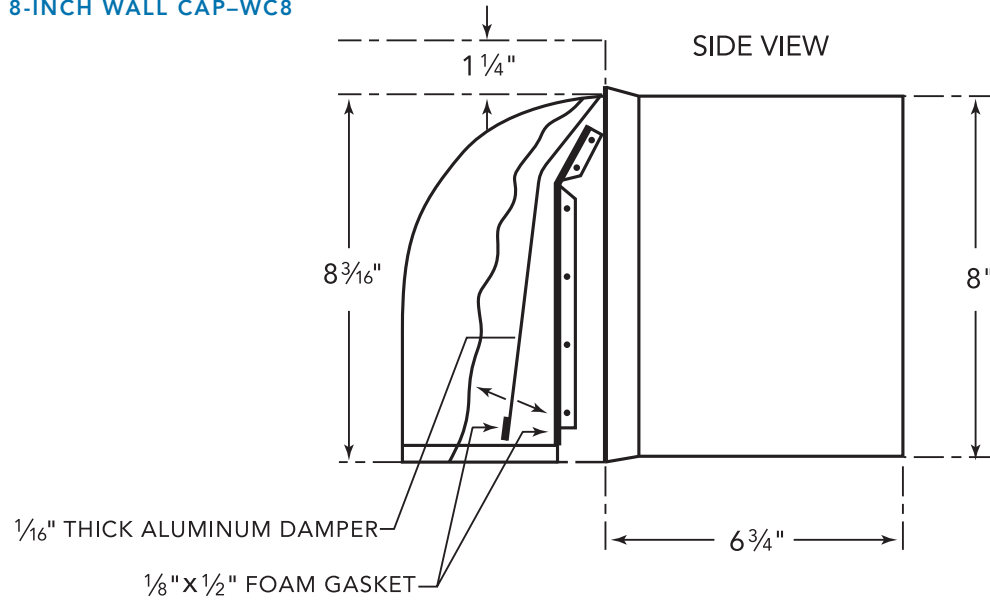

These warranties give you specific legal rights and you may have other rights that vary from state to state. Full warranty and limited warranty from date of installation. For complete warranty details, refer to your Use & Care manual, or ask your dealer.

Specifications are for planning purposes only. Refer to installation instructions and consult your countertop supplier prior to making counter opening. Consult with a heating and ventilation engineer for your specific ventilation requirements. For the most detailed information, refer to installation instructions accompanying product or write to Thermador indicating the model number. Specifications are correct at time of printing. Thermador reserves the right to change product specifications or design without notice. Some models are certified for use in Canada. Thermador is not responsible for products that are transported from the U.S. for use in Canada.