

# C30GGXU1

Cooker size	30"X25"
N. of cavities with energy label	1
Hob type	Gas
Type of main oven	Gas with gas grill
EAN code	8017709179236



## Programme / Functions

No. of cooking functions	2
Other functions	



Defrost by time

## Aesthetics



Colour	Stainless steel	Controls colour	Soft touch black
Aesthetics	Mista	No. of controls	8
Series	Symphony	Serigraphy colour	Black
Design	Square design	Handle	Smeg Classic
Door	With 2 horizontal strips	Handle Colour	Brushed stainless steel
Upstand	Yes	Glass type	Stopsol
Type of pan stands	Cast Iron	Feet	Silver
Hob colour	Stainless steel	Logo	Assembled
Command panel finish	Stainless steel	Logo position	Facia below the oven
Control knobs	Smeg USA		

## Hob technical features

Total no. of cook zones	5	Gas safety valves	Yes
Type of gas burners	Simmer USA	Burner caps	Matt black enamelled

Automatic electronic ignition Yes

## Main Oven Technical Features



No. of lights	2	Full glass inner door	Yes
Cavity material	Easy Clean enamel	Total no. of door glasses	3
No. of shelves	4	No. of thermo-reflective door glasses	2
Type of shelves	Molded sides	Cooling system	Tangential
Light type	Halogen	Usable cavity space dimensions (HxWxD)	335X670X435 mm
Light Power	40 W	Temperature control	Mechanical
Cooking time setting	Minute minder	Grill type	Gas
Removable door	Yes		

## Options Main Oven

Minimum Temperature	150 °C	Maximum temperature	276 °C
---------------------	--------	---------------------	--------

## Accessories included for Main Oven & Hob

Cast iron wok support	1	Oven grid with stop, tray support	2
Moka stand in cast iron	1	20mm deep tray	1

## Electrical Connection

Plug	(B) USA 120V	Power supply cable length	120 cm
Voltage	120 V	Terminal block	3 poles
Frequency	60 Hz		

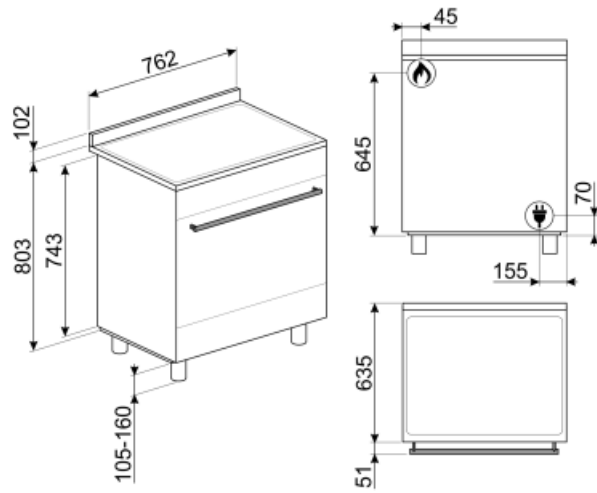

---

## Not included accessories

---



**SFLK1**  
Child lock

**KITPAX**  
High extension feet (950 mm), stainless steel, suitable for Master, Symphony and Concertcookers





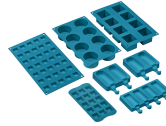





**8MCCU**  
kit 8 Classic knobs



**SMOLD**  
Set of 7 silicone moulds for ice creams, ice lollies, pralines, ice cubes or to portion food. Usable from -60°C to +230°C

## Symbols glossary

---

- |  |   |   |   |
|--|---|---|---|
|  | Heavy duty cast iron pan stands: for maximum stability and strength.  |  | Air cooling system: to ensure a safe surface temperatures.  |
|  | Defrost by time: with this function the time of thawing of foods are determined automatically.  |  | Triple glazed doors: Number of glazed doors.  |
|  | Enamel interior: The enamel interior of all Smeg ovens have a special antacid lining which helps keep the interior clean by reducing the amount of cooking grease adhering to it. |  | Gas ovens offer instantaneous heat control, reduced cooking times and the ability to bake at much lower temperatures than electric ovens. |
|  | All glass inner door: All glass inner door, a single flat surface which is simple to keep clean.  |  | Side lights: Two opposing side lights increase visibility inside the oven.  |
|  | The oven cavity has 4 different cooking levels.   |   |   |