

CPF48UGMAN

Cooker size	120x60 cm
N. of cavities with energy label	2
Hob type	Gas
Type of main oven	Thermo-ventilated
Type of second oven	Static
EAN code	8017709266783



Aesthetics













Aesthetics	Portofino	No. of controls	10
Colour	Anthracite	Serigraphy colour	Black
Design	Flush fit	Handle	Smeg Portofino
Door	With frame	Handle Colour	coloured
Upstand	Yes	Glass type	Grey
Type of pan stands	Cast Iron	Plinth	Black
Hob colour	Stainless steel	Storage compartment	Door
Command panel finish	Enamelled metal	Sliding compartment	Yes
Control knobs	Smeg Portofino	Logo	Assembled st/steel
Controls colour	Stainless steel	Logo position	Facia below the oven
Display	Touch	Alternative colours available	Stainless steel, Black, White, Red, Olive green, Yellow, Orange

Programme / Functions

No. of cooking functions	9
--------------------------	---

Traditional cooking functions

 Static	 Fan assisted	 Circulaire
 Small grill	 Large grill	 Fan grill (large)
 Base	 Fan assisted base	 Pizza
 Rotisserie		

Cleaning functions

 Vapor Clean
--

Other functions

 Defrost by time
--

Programme / Functions Auxiliary Oven

Bottom element + fan



Hob technical features

Total no. of cook zones 6

Type of gas burners	Standard	Gas safety valves	Yes
Automatic electronic ignition	Yes	Burner caps	Matt black enamelled

Main Oven Technical Features



No. of lights	2	Safety Thermostat	Yes
Fan number	3	Cooling system	Tangential
Cavity material	Easy clean enamel	Usable cavity space dimensions (HxWxD)	305X613X405 mm
No. of shelves	5	Temperature control	Electro-mechanical
Type of shelves	Metal racks	Lower heating element power	1700 W
Light type	Halogen	Upper heating element - Power	1200 W
Light power	40 W	Grill element	1700 W
Cooking time setting	Start and Stop	Large grill - Power	2900 W
Light when oven door is open	Yes	Circular heating element - Power	1500 W
Door opening	Flap down	Grill type	Electric
Removable door	Yes	Tilting grill	Yes
Total no. of door glasses	3	Soft Close system	Yes
No. of thermo-reflective door glasses	2		

Options Main Oven

Timer	Yes	Minimum Temperature	50 °C
End of cooking acoustic alarm	Yes	Maximum temperature	250 °C

Second Oven Technical Features



Cavity material	Easy clean enamel	No. thermo-reflective door glasses	2
No. of shelves	5	Safety Thermostat	Yes
Type of shelves	Metal racks	Cooling system	Tangential
No. of lights	2	Usable cavity space dimensions (HxWxD)	315x300x415 mm
Light type	Halogen	Temperature control	Electro-mechanical
Light power	40 W	Lower heating element - power	750 W
Light when oven door is open	Yes	Large grill - Power	2050 W
Door opening	Flap down	Circular heating element - Power	1500 W
Removable door	Yes	Grill type	Electric
No. total door glasses	3	Tilting grill	Yes

Options Auxiliary Oven

Minimum Temperature	50 °C	Maximum temperature	220 °C
---------------------	-------	---------------------	--------

Accessories included for Main Oven & Hob



Cast iron wok support	1	40mm deep tray	1
Rotisserie	1	Telescopic Guide rails, total Extraction	1
Top oven chrome shelf with back stop	2		

Accessories included for Secondary Oven



Chrome shelf with back and side stop	1	Wide baking tray	1
Grill mesh	1	Telescopic Guide rails, total Extraction	1

Electrical Connection

Nominal power	8000 W	Frequency	60 Hz
Voltage	120-240 V	Power supply cable length	120 cm
Voltage 2 (V)	120/208 V	Terminal block	5 poles

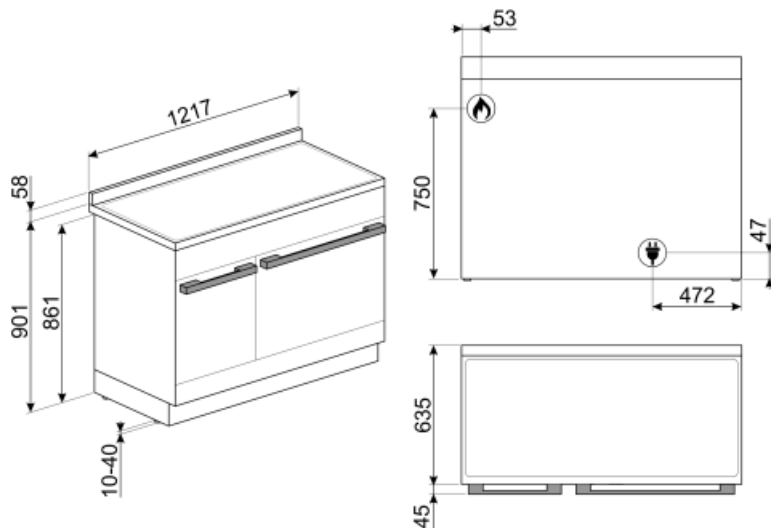

Not included accessories



PAL2

Paletta pizza larga con doppio manico.



SFLK1



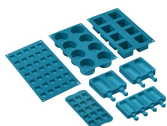















Child lock



SMOLD

Set of 7 silicone moulds for ice creams, ice lollies, pralines, ice cubes or to portion food. Usable from -60°C to +230°C

Symbols glossary

 <p>Heavy duty cast iron pan stands: for maximum stability and strength.</p>	 <p>Air cooling system: to ensure a safe surface temperatures.</p>
 <p>Defrost by time: with this function the time of thawing of foods are determined automatically.</p>	 <p>Triple glazed doors: Number of glazed doors.</p>
 <p>Enamel interior: The enamel interior of all Smeg ovens have a special antacid lining which helps keep the interior clean by reducing the amount of cooking grease adhering to it.</p>	 <p>Circogas: In gas ovens the fan distributes the heat quickly and evenly throughout the oven cavity, avoiding flavour transfer when cooking a number of different dishes at the same time. In electric ovens this combination completes cooking more quickly of foods that are ready on the surface, but that require more cooking inside, without further browning.</p>
 <p>Fan with upper and lower elements: The elements combined with the fan aim to provide more uniform heat, a similar method to conventional cooking, so pre-heat is required. Most suitable for items requiring slow cooking methods.</p>	 <p>Upper and lower element only: a traditional cooking method best suited for single items located in the centre of the oven. the top pf the oven will always be hottest. Ideal for roast, fruit cakes, bread etc.</p>
 <p>Lower heating element only: This function is ideal for foods that require extra base temperature without browning, e.g. pastry dishes, pizza. Also suitable for slow cooking of stews and casseroles.</p>	 <p>Circulaire: The combination of the fan and circular element around it gives a hot air cooking method. This provides many benefits including no preheat if cook time is more than 20 minutes, no flavour transfer when cooking different foods at the same time, less energy, and shorter cook times. Good for all types of food.</p>
 <p>Grill element: Using of grill gives excellent results when cooking meat of medium and small portions, especially when combined with a rotisserie (where possible). Also ideal for cooking sausages and bacon.</p>	 <p>Half grill: For rapid cooking and browning of foods. Best results can be obtained by using the top shelf for small items, the lower shelves for larger ones, such as chops or sausages. For half grill heat is generated only at the centre of the element, so is ideal for smaller quantities.</p>
 <p>Fan with grill element: The fan reduces the fierce heat from the grill, providing an excellent method of grilling various foods, chops, steaks, sausages etc. giving even browning and heat distribution, without drying out the food. The top two levels recommended for use, and the lower part of the oven can be used to keep items warm at the same time, an excellent facility when cooking a grilled breakfast. Half grill (centre portion only) is ideal for small quantities of food.</p>	 <p>Pizza function: The simultaneous operation of three elements ensures an optimum cooking facility when used with the Smeg pizza stone.</p>
 <p>Rotisserie: The rotisserie (where installed) works in combination with the grill element to brown foods to perfection.</p>	 <p>Side lights: Two opposing side lights increase visibility inside the oven.</p>
 <p>The oven cavity has 5 different cooking levels.</p>	 <p>Soft close: all models are equipped with advanced function of smooth closing of the door, which allows the device to close smoothly and quietly.</p>



Telescopic rails: allow you to pull out the dish and check it without having to remove it from the oven entirely.



Electronic control: Allows you to maintain temperature inside the oven with the precision 2-3 ° C. This enables to cook meals that are very sensitive to temperature changes, such as cakes, souffles, puddings.



Tilting grill: the tilting grill can be easily unhooked to move the heating element and clean the roof of the appliance in one simple step.



Vapor Clean: a simple cleaning function using steam to loosen deposits in the oven cavity.