

SX96VJMK9

Cooker size	90x60 cm
N. of cavities with energy label	1
Hob type	Gas
Type of main oven	Gas with gas grill
EAN code	8017709222758



Programme / Functions

No. of cooking functions	1
Traditional cooking functions	

 Rotisserie + grill

Aesthetics

			
Colour	Stainless steel	Controls colour	Soft touch black
Aesthetics	Classic	No. of controls	9
Series	Concert	Serigraphy colour	Black
Design	Standard	Handle	Smeg Classic
Door	With frame	Handle Colour	Brushed stainless steel
Upstand	Yes	Glass type	Stopsol
Type of pan stands	Cast Iron	Feet	Silver
Hob colour	Stainless steel	Storage compartment	Door
Command panel finish	Stainless steel	Logo	Assembled
Control knobs	Smeg USA	Logo position	Facia below the oven

Hob technical features

Total no. of cook zones	6		
Type of gas burners	Standard	Gas safety valves	Yes
		Burner caps	Matt black enamelled

Automatic electronic ignition Yes

Main Oven Technical Features



No. of lights	2	Full glass inner door	Yes
Cavity material	Easy Clean enamel	Removable inner door	Yes
No. of shelves	5	Total no. of door glasses	3
Type of shelves	Metal racks	No. of thermo-reflective door glasses	2
Light type	Halogen	Safety Thermostat	Yes
Light Power	40 W	Cooling system	Tangential
Cooking time setting	Minute minder	Usable cavity space dimensions (HxWxD)	340x724x418 mm
Door opening	Flap down	Temperature control	Electro-mechanical
Removable door	Yes	Grill type	Gas

Accessories included for Main Oven & Hob

Rotisserie	1	Grill mesh	1
Chrome shelf with back stop	1	40mm deep tray	1

Electrical Connection

Nominal power	70 W	Power supply cable length	120 cm
Voltage	127 V	Terminal block	3 poles
Frequency	50/60 Hz		

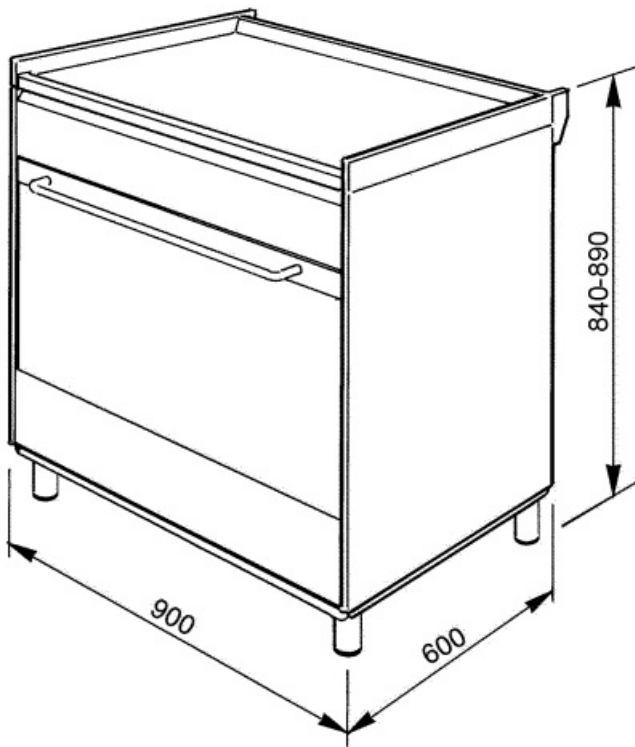

Not included accessories



PPR9

Refractory pizza stone without handles. Squared shaped stone: L64xH2,3xP37,5 cm Suitable also for gas ovens, to be put on the griddle.

KITPAX

High extension feet (950 mm), stainless steel, suitable for Master, Symphony and Concertcookers

GTT

Totally extractable telescopic guides (1 level) Extraction: 433 mm Material: Stainless steel AISI 430 polished



SFLK1

Child lock

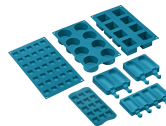

SMOLD











Set of 7 silicone moulds for ice creams, ice lollies, pralines, ice cubes or to portion food. Usable from -60°C to +230°C

GTP

Partially extractable telescopic guides (1 level) Extraction: 300 mm Material: Stainless steel AISI 430 polished



Symbols glossary

	Heavy duty cast iron pan stands: for maximum stability and strength.		Air cooling system: to ensure a safe surface temperatures.
	Triple glazed doors: Number of glazed doors.		Enamel interior: The enamel interior of all Smeg ovens have a special antacid lining which helps keep the interior clean by reducing the amount of cooking grease adhering to it.
	Rotisserie with half grill: These symbols allow use of the rotisserie with half grill.		Gas ovens offer instantaneous heat control, reduced cooking times and the ability to bake at much lower temperatures than electric ovens.
	All glass inner door: All glass inner door, a single flat surface which is simple to keep clean.		The inner door glass: can be removed with a few quick movements for cleaning.
	Side lights: Two opposing side lights increase visibility inside the oven.		The oven cavity has 5 different cooking levels.