

# SF6341GX



|                |                    |
|----------------|--------------------|
| Product Family | Oven               |
| Category       | 60cm               |
| Power supply   | Gas                |
| Heat source    | Gas                |
| Cooking method | Static             |
| Oven control   | Electro-mechanical |
| EAN code       | 8017709206727      |



## Aesthetics

|               |                 |                   |                          |
|---------------|-----------------|-------------------|--------------------------|
| Aesthetics    | Classic         | Serigraphy colour | Black                    |
| Colour        | Stainless steel | Serigraphy type   | Symbols                  |
| Finishing     | Fingerproof     | Door              | With 2 horizontal strips |
| Design        | Flat            | Handle            | Classic                  |
| Material      | Stainless steel | Handle Colour     | Stainless steel          |
| Type of steel | Brushed         | Logo              | Embossed                 |
| Glass Type    | Eclipse         |                   |                          |

## Controls

|                 |               |                 |              |
|-----------------|---------------|-----------------|--------------|
| Control setting | Control knobs | Control knobs   | Classic      |
| No. of controls | 2             | Controls colour | Steel effect |

## Programme / Functions

|                               |   |
|-------------------------------|---|
| No. of cooking functions      | 2 |
| Traditional cooking functions |   |



Large grill



Base

## Options

|                      |                    |               |     |
|----------------------|--------------------|---------------|-----|
| Timer                | Electro-mechanical | Minute minder | Yes |
| Time-setting options | No delay options   |               |     |

## Technical Features



|                       |                    |
|-----------------------|--------------------|
| Temperature control   | Electro-mechanical |
| Minimum Temperature   | 150 °C             |
| Maximum temperature   | 265 °C             |
| Cavity material       | Easy clean Enamel  |
| No. of shelves        | 4                  |
| Shelves type          | Metal racks        |
| No. of lights         | 1                  |
| Light type            | Halogen            |
| Light Power           | 40 W               |
| Grill element - power | 1800 W             |
| Door                  | Fresh Touch        |

|  |                |
|--|----------------|
| Removable door                         | Yes            |
| Full glass inner door                  | Yes            |
| Removable inner door                   | Yes            |
| Total no. of door glasses              | 3              |
| No. of thermoreflecting door glasses   | 1              |
| Safety Thermostat                      | Yes            |
| Cooling system                         | Tangential     |
| Cooling duct                           | Double         |
| Gas safety valve                       | Yes            |
| Usable cavity space dimensions (HxWxD) | 316x460x412 mm |

## Performance / Energy Label



|   |           |
|---|-----------|
| Energy efficiency class                           | A         |
| Net volume of the cavity                          | 66 litres |
| Energy consumption per cycle in conventional mode | 1.69 KWh  |
| GAS - Energy consumption in conventional mode     | 6.10 MJ   |

|                         |        |
|-------------------------|--------|
| Number of cavities      | 1      |
| Energy efficiency index | 94.9 % |
| Gross volume            | 70 l   |

## Accessories Included

|              |   |                                  |   |
|--------------|---|----------------------------------|---|
| Chrome shelf | 1 | Extra deep enamelled tray (40mm) | 1 |
|--------------|---|----------------------------------|---|

## Electrical Connection

|                   |           |                           |          |
|-------------------|-----------|---------------------------|----------|
| Voltage           | 220-240 V | Frequency (Hz)            | 50/60 Hz |
| Nominal power (W) | 1900 W    | Power supply cable length | 115 cm   |
| Current           | 9 A       |                           |          |

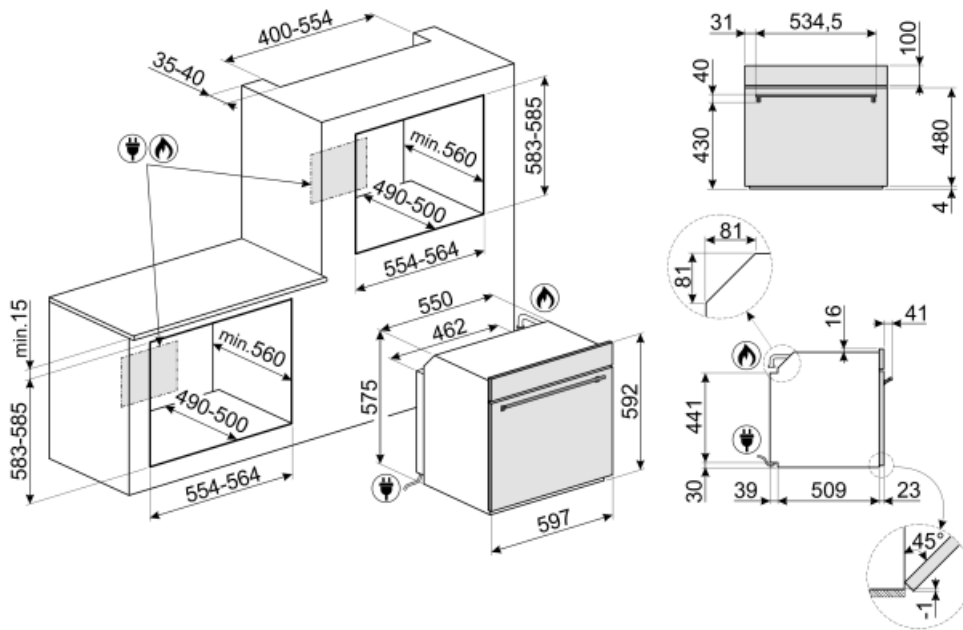

## Not included accessories



### PR3845X

Antifingerprint stainless steel. Cover for furniture in column installation of more ovens



### GT1T-2

Totally extractable telescopic guides (1 level) for ovens with metal frames. Length: 355.5 mm, extraction: 418.5 mm. Material: Stainless steel AISI 430 polished.



### PALPZ

Pizza shovel with fold away handle width: 315mm length : 325mm



### BN640

Enamelled tray, 40mm deep



### SFLK1

Child lock



### GTT

\*\*Totally extractable telescopic guides (1 level)\*\* Extraction: 433 mm Material: Stainless steel AISI 430 polished



### GT1P-2

Partially extractable telescopic guides (1 level) for ovens with metal frames. Length: 355.5 mm, extraction: 285 mm. Material: Stainless steel AISI 430 polished.



### PRTX

Refractory pizza stone with handles. D=35cm Not suitable for microwave ovens. Suitable for gas ovens, to be put on the griddle.



### BN620-1

Enamelled tray, 20mm deep



### BNP608T

Teflon-coated tray, 8mm depth, to be placed on the grid

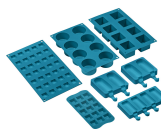

### SMOLD















Set of 7 silicone moulds for ice creams, ice lollies, pralines, ice cubes or to portion food. Usable from -60°C to +230°C



### GTP

\*\*Partially extractable telescopic guides (1 level)\*\* Extraction: 300 mm Material: Stainless steel AISI 430 polished

## Symbols glossary

|  |  |
|--|--|
|  <p>A: Product drying performance, measured from A+++ to D / G depending on the product family</p>   |  <p>Air cooling system: to ensure a safe surface temperatures.</p>  |
|  <p>Triple glazed doors: Number of glazed doors.</p>   |  <p>Enamel interior: The enamel interior of all Smeg ovens have a special antacid lining which helps keep the interior clean by reducing the amount of cooking grease adhering to it.</p>                     |
|  <p>Fresh Touch: Most of Smeg ovens have a "cool door." Thanks to the combination of tangential cooling and internal heat-reflecting glasses, the temperature on the outer surface of the door is maintained below 50° C. In addition to providing safety, this system protects the sides of the furniture from overheating by the oven.</p> |  <p>Lower heating element only: This function is ideal for foods that require extra base temperature without browning, e.g. pastry dishes, pizza. Also suitable for slow cooking of stews and casseroles.</p> |
|  <p>Grill element: Using of grill gives excellent results when cooking meat of medium and small portions, especially when combined with a rotisserie (where possible). Also ideal for cooking sausages and bacon.</p>  |  <p>Gas ovens offer instantaneous heat control, reduced cooking times and the ability to bake at much lower temperatures than electric ovens.</p>   |
|  <p>All glass inner door: All glass inner door, a single flat surface which is simple to keep clean.</p>   |  <p>The inner door glass: can be removed with a few quick movements for cleaning.</p>   |
|  <p>Side lights: Two opposing side lights increase visibility inside the oven.</p>   |  <p>The oven cavity has 4 different cooking levels.</p>   |
|  <p>The capacity indicates the amount of usable space in the oven cavity in litres.</p>  |  <p>The capacity indicates the amount of usable space in the oven cavity in litres.</p>   |