

# SE395ETB

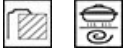

<b>Product Family</b>	Hob
<b>Built-in</b>	Ultra-low profile
<b>Dimensions</b>	90 cm
<b>Power supply</b>	Electric
<b>Type</b>	Ceramic
<b>EAN code</b>	8017709233754



## Aesthetics



<b>Colour</b>	Black
<b>Finishing</b>	Glass
<b>Aesthetics</b>	Universal
<b>Material</b>	Glass
<b>Glass Type</b>	Ceramic
<b>Glass edge</b>	Angled edge
<b>Type of control setting</b>	Touch control
<b>Control knobs position</b>	Front
<b>Serigraphy colour</b>	Grey

## Programme / Functions



<b>Total no. of cook zones</b>	5
<b>No. of ceramic cook zones</b>	5
<b>No. of cooking zones with booster</b>	5
<b>Power levels</b>	9

## Options



<b>Standard cut out</b>	490x850 mm	<b>Limited Power Consumption Mode</b>	Yes
<b>Keep warm automatic function</b>	Yes		

End cooking timer	5	Limited Power	2800, 4000 W
Minute minder	1	Consumption Mode in W	
End of cooking acoustic alarm	Yes	Show Room Demo Option	Yes
Residual time indicator	Yes	Control Lock / Child Safety	Yes
		Quick start	Yes

## Technical Features



Front left - Ceramic - double - Ø 12.4 - Ø 18.4 cm  
 Rear left - Ceramic - single - Ø 14.8 cm  
 Central - Ceramic - triple - Ø 15.0 - Ø 21.6 - Ø 28.8 cm  
 Rear right - Ceramic - single - Ø 19.9 cm  
 Front right - Ceramic - single - Ø 14.8 cm

Automatic switch off when overheat Yes  
 Automatic switch off when overflow Yes

Residual heat indicator Yes

## Electrical Connection

Nominal power (W)	9100 W	Type of electric cable	Single and Double phase
Current	26 A	Frequency (Hz)	50/60 Hz
Voltage (V)	220-240 V	Power supply cable length	150 cm
Voltage 2 (V)	380-415 V	Terminal Box	6 poles

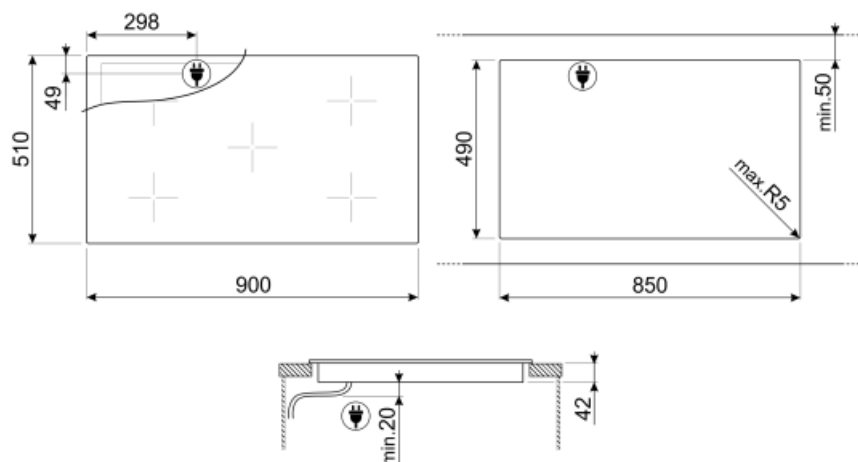

## Not included accessories













---



### SCRP

Induction and ceramic hobs and teppanyaki scraper

## Symbols glossary

 <p><b>Power booster:</b> option allows the zone to work at full power when very intense cooking is necessary.</p>	 <p><b>Ultra-low profile:</b> Installation of product with flat edge - height of 1 mm.</p>
 <p><b>Child lock:</b> some models are fitted with a device to lock the programme/cycle so it cannot be accidentally changed.</p>	 <p><b>ECO-logic:</b> option allows you to restrict the power limit of the appliance real energy saving.</p>
 <p><b>Keep warm function:</b> Keep warm function keeps the cooked food heated. In this mode the heating zone operates at a minimum capacity for 120 minutes and then turns off automatically.</p>	 <p><b>Overheat protection:</b> The safety system that automatically turns off the hob in case of overheating of the control unit.</p>
 <p><b>Glass ceramic:</b> The base of the hob is made glass ceramic. Heating is performed by the heating elements Hi-Light.</p>	 <p><b>Overfill protection:</b> The special overfill protection shuts down the stove in the presence of overflow of liquids.</p>
 <p><b>Quick Start function:</b> the chosen temperature is reached faster. The heating element works at maximum power until the right temperature is reached.</p>	 <p><b>Indication of residual heat:</b> After the glass ceramic hob is switched off the residual heat indicator shows which of the heating zones still remains hot. When the temperature drops below 60 ° C, the indicator goes out.</p>
 <p><b>Time elapsed:</b> shows how long the cooking zone has been in use.</p>	 <p><b>Timer:</b> All ceramic hobs have a timer which automatically ends cooking after a preset time.</p>
 <p><b>Touch controls:</b> Easy to use touch controls allow the appliance to be programmed at the touch of a button.</p>	