

FMIU020X

Usable volume

20 l



Product Family

Microwave

Category

Built-in

Installation

With frame

Power supply

Electric

Cooking Method

Microwave with grill

Control

Electromechanical



Programme / Functions

No. of functions

6

Full grill



Pizza



Defrost by time



Defrost by weight



Microwave



Microwave + grill



Automatic programmes

8

Controls

Display / Clock

1 a LED

Type of control setting

Control knobs / buttons

Opening

Mechanical button

No. of controls

1

Control knobs

Push-push

Controls colour

Steel effect

Buttons Colour

Steel effect

Options



Timer

Electronic

Time-setting options

End cooking

Controls Lock / Child Safety

Yes

Quick start option

Yes

End of cooking acoustic alarm Yes

Technical Features



Cavity material	Stainless steel	Door opening	Side-opening
No. of lights	1	Total no. of door glasses	1
Light type	LED	Safety Thermostat	Yes
Turntable	Yes	Cooling system	Tangential
Turntable dimensions	24,5 cm	Microwave screen protection	Yes
Light when door is opened	Yes	Microwave stops when door is opened	Yes
Grill type	Heating element	Usable cavity space dimensions (HxWxD)	218x315x295 mm
Grill - power	1000 W	Microwave effective power	800 W

Accessories Included







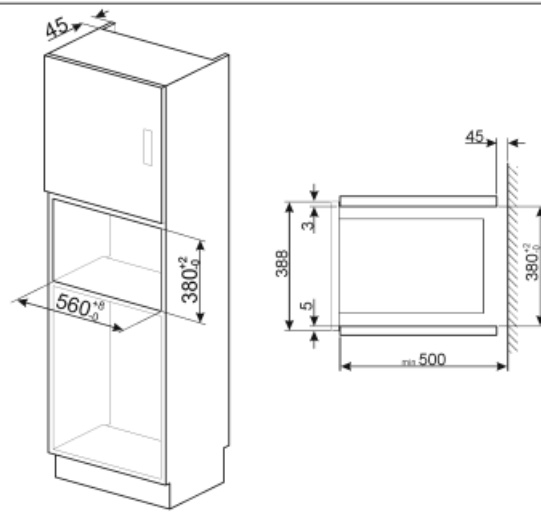
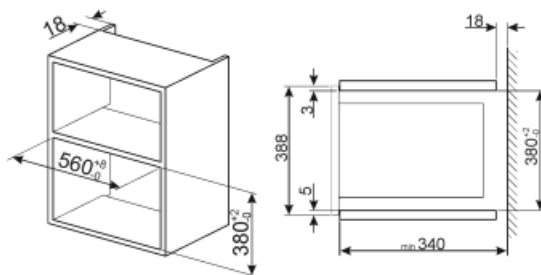
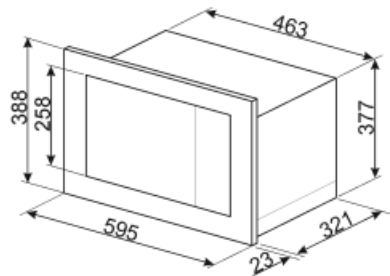



Grid	1	Frame	Yes
-------------	---	--------------	-----

Electrical Connection

Nominal power (W)	1350 W	Frequency (Hz)	60 Hz
Current	11 A	Power supply cable length	150 cm
Voltage (V)	120 V		



Symbols glossary

- | | | | |
|--|---|---|--|
|  | Child lock: some models are fitted with a device to lock the programme/cycle so it cannot be accidentally changed. |  | Microwave energy shortens cooking times dramatically and produces energy savings. |
|  | Defrost by time: with this function the time of thawing of foods are determined automatically. |  | Defrost by weight: With this function the defrosting time is determined |
|  | Grill element: Using of grill gives excellent results when cooking meat of medium and small portions, especially when combined with a rotisserie (where possible). Also ideal for cooking sausages and bacon. |  | Microwave: Penetrating straight into the food, microwaves cook very quickly and with considerable energy savings. Suitable for cooking without fat, they are also able to thaw and heat food without altering its original appearance and aroma. The microwave function can also be combined with conventional functions with all the resulting advantages. Ideal for all types of food. |
|  | Microwave + grill element: The use of the grill results in a perfect browning of the surface of the food. The action of microwaves allows instead of cooking in a short time the internal part of the food. |  | Pizza microwave: This function cooks pizza quicker thanks to the microwaves. To optimize the final result, use the function combined with the Chef plate |
|  | Side lights: Two opposing side lights increase visibility inside the oven. |  | The capacity indicates the amount of usable space in the oven cavity in litres. |