

# FAB32ULRD3



<b>Product Family</b>	Refrigerators
<b>Installation</b>	Free Standing
<b>Category</b>	Bottom Mount
<b>No-Frost system</b>	Total
<b>Cooling type</b>	No frost
<b>Defrost</b>	Automatic
<b>Hinge type</b>	Standard
<b>Hinge position</b>	Left
<b>EAN code</b>	8017709272074



## Aesthetics

<b>Colour</b>	Red	<b>Logo colour</b>	Chrome
<b>Finishing</b>	Gloss	<b>Side material</b>	Steel
<b>Aesthetics</b>	50's Style	<b>Side colour</b>	Red
<b>Design</b>	Rounded	<b>Logo</b>	Applied
<b>Material</b>	Heat-moulded	<b>Door shelves profile color</b>	Chrome
<b>Handle</b>	External	<b>Drawers profile color</b>	Chrome
<b>Handle type</b>	Fixed	<b>Color of glass shelf profile</b>	Chrome
<b>Handle colour</b>	Chrome	<b>Display</b>	7 segments

## Refrigerator compartment features



<b>No. of adjustable shelves</b>	3	<b>Type of crisper/vegetable drawers cover</b>	Glass
<b>Number of fruit and vegetables drawers</b>	1	<b>Life Plus zone-0°C</b>	Yes, with electronic control
<b>Type of adjustable shelves</b>	Glass	<b>Internal light in fridge</b>	Yes
<b>Type of crisper/vegetable drawers cover</b>	Standard	<b>Type of internal light (fridge)</b>	LED
<b>Crisper Cover</b>	Yes		

## Refrigerator Inner Door

No. of door shelves with transparent cover 1

Number of adjustable door shelves 2

Adjustable door shelves with wire support Yes

No. of bottle shelves 1

Bottle shelves with wire support Yes

## Other Refrigerator features



Accessories  
MultiFlow

Egg tray  
Yes

Fan

Yes

## Freezer compartment features

Number of drawers 2

No. of compartments with flap 1

Type of shelves

Plastic

## Other Freezer features



Accessories

1 ice box

Fast freezing compartment

Yes

## Other technical features

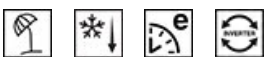

Functions display

Holiday, Fast freezing, Fast cooling, ECO, Temperature alarm

Fast freezing button

Yes

Power on lamp

Yes

Temperature alarm lamp

Yes

Door open alarm

Acoustic and visual

Temperature Alarm

Yes

Type of temperature control

Electronic

No. of compressors

1

Refrigerant gas type

R600a

Type of compressor

Variable Speed Compressor

Refrigerant Quantity (gr)

60 gr

Foam agent

Cyclopentane

## Performance / Energy Label









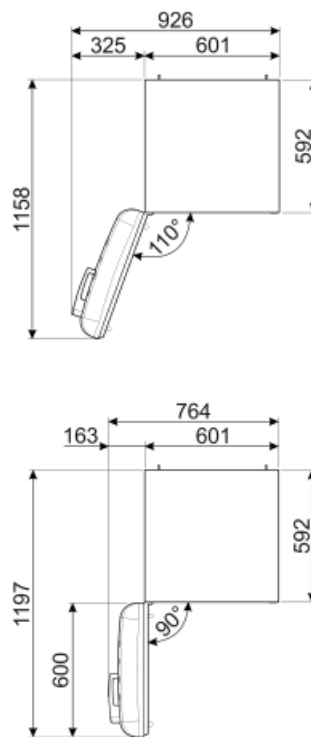
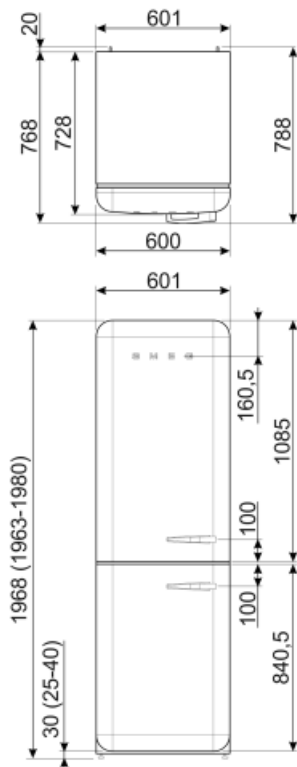





<b>Category of the household refrigerating appliance model</b>	Refrigerator - freezer	<b>Chiller compartment net volume</b>	30 l
<b>Noise level</b>	37 dB(A) re 1pW	<b>Storage volume frozen food compartment</b>	97 l
<b>Energy efficiency class</b>	A+++	<b>4 Star compartment - Star rating</b>	4
<b>Annual energy consumption</b>	178 kWh/year	<b>Freezing capacity</b>	6 Kg/24h
<b>Climatic class</b>	SN, N, ST, T	<b>Total storage volume</b>	331 l
<b>Fresh Food compartment - Storage Volume</b>	204 l	<b>Thaw time</b>	40 h
<b>Total gross volume</b>	365 l		

## Electrical Connection

<b>Plug</b>	(A) USA e Messico	<b>Voltage (V)</b>	115 V
<b>Nominal power</b>	127 W	<b>Frequency (Hz)</b>	50/60 Hz
<b>Current</b>	0.80 A	<b>Power supply cable length</b>	200 cm



## Symbols glossary

- |  |  |   |   |
|--|--|---|---|
|    | 4 stars freezing compartment for better food preservation.   |    | A+++: Appliances with this symbol can reduce energy consumption by a further 30% from the standard A energy rating.   |
|    | The automatic defrost system works by automatically defrosting at regular intervals eliminating the need to defrost altogether.            |    | Economical mode: Analyzes fridge functioning during the activation and optimizes the operating cycle in order to reduce power consumption.  |
|    | Ventilated: Forced distribution of cold air in the refrigerator compartment, which allows even temperature distribution within the fridge. |    | Fast freezing: The fast freezing function brings the temperature of the compartment down when activated a few hours prior to usage.   |
|    | Power saving mode: The power saving mode allows you to disable the refrigerator and keep the freezer working.                              |    | LED interior lighting: is a more energy efficient and long lasting way of illuminating the interior of the appliance.   |
|    | Life Plus 0°C: The temperature in the Lifeplus compartments is kept at 0°C, which preserves fresh meat and fish longer.                    |    | Inverter technology: The evolution of Smeg's driers towards more intelligent and environmentally sustainable models has led to the choice of using Inverter technology with heat pumps, which reduces significantly energy consumption. |
|  | Air plus: keeps food fresher for longer.   |  | No Frost: The No Frost and Frost free systems prevent ice from forming so that no defrosting is required.   |