

FAB28ULPB3



Product Family	Refrigerators
Installation	Free Standing
Category	One Door
Cooling type	Static
Defrost	Automatic for refrigerator, manual for freezer
Hinge type	Standard
Hinge position	Left
EAN code	8017709271800



Aesthetics

Colour	Pastel blue	Logo colour	Chrome
Finishing	Gloss	Side material	Steel
Aesthetics	50's Style	Side colour	Pastel blue
Design	Rounded	Logo	Applied
Material	Heat-moulded	Door shelves profile color	Chrome
Handle	External	Drawers profile color	Chrome
Handle type	Fixed	Color of glass shelf profile	Chrome
Handle colour	Chrome		

Refrigerator compartment features



No. of adjustable shelves	3	Bottle shelf	Yes
Number of fruit and vegetables drawers	1	Type of crisper/vegetable drawers cover	Glass
Type of adjustable shelves	Glass	Life Plus zone-0°C	0°C
Type of crisper/vegetable drawers cover	On sliding rails	Internal light in fridge	Yes
Crisper Cover	Yes	Type of internal light (fridge)	LED

Refrigerator Inner Door

No. of bottle shelves	1
-----------------------	---

No. of door shelves with transparent cover 2

Bottle shelves with wire support Yes

Number of adjustable door shelves 2

Adjustable door shelves with wire support Yes

Freezer compartment features

Internal freezer compartment Yes

Other technical features



Door open alarm	Acoustic and visual
Antibacterial Gasket	Yes
Type of temperature control	Electronic
No. of compressors	1
Refrigerant gas type	R600a
Type of compressor	Variable Speed Compressor
Refrigerant Quantity (gr)	34 gr
Foam agent	Cyclopentane

Performance / Energy Label







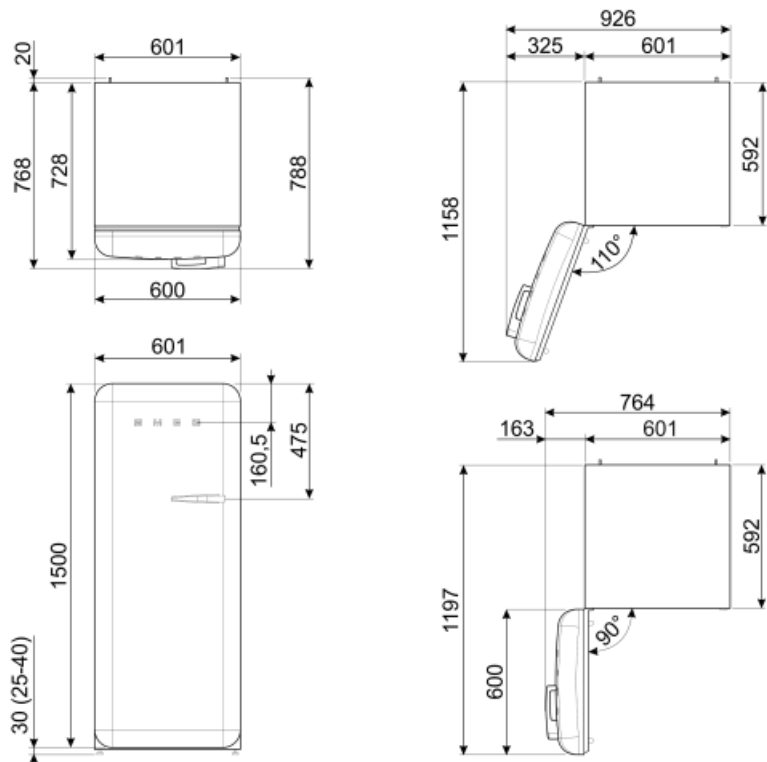

Category of the household refrigerating appliance model	Refrigerator - freezer	Storage volume frozen food compartment	26 l
Energy efficiency Index EEI	21.7 %	4 Star compartment - Star rating	4
Annual energy consumption	139 KWh/year	Gross volume frozen food compartment	26 l
Fresh Food compartment - Storage Volume	223 l	Total storage volume	270 l
Total gross volume	281 l	Gross volume fresh food compartment	255 l
Chiller compartment net volume	21 l		

Electrical Connection

Plug	(A) USA e Messico	Frequency (Hz)	50/60 Hz
Current	2 A	Power supply cable length	150 cm
Voltage (V)	120 V		



Symbols glossary

- | | | | |
|--|---|---|---|
|  | 4 stars freezing compartment for better food preservation. |  | The automatic defrost system works by automatically defrosting at regular intervals eliminating the need to defrost altogether. |
|  | Antibacterial treatment: antibacterial treatment to ensure better hygiene |  | LED interior lighting: is a more energy efficient and long lasting way of illuminating the interior of the appliance. |
|  | Life Plus 0°C: The temperature in the Lifeplus compartments is kept at 0°C, which preserves fresh meat and fish longer. |  | Inverter technology: The evolution of Smeg's driers towards more intelligent and environmentally sustainable models has led to the choice of using Inverter technology with heat pumps, which reduces significantly energy consumption. |