

CPF36UGGX

Cooker size	90x60 cm
N. of cavities with energy label	1
Hob type	Gas
Type of main oven	Gas with gas grill
EAN code	8017709259075



Programme / Functions

No. of cooking functions	3
Traditional cooking functions	



Large grill



Base



Fan assisted base

Other functions



Defrost by time

Aesthetics



Colour	Stainless steel	No. of controls	8
Aesthetics	Portofino	Serigraphy colour	Silver
Design	Flush fit	Handle	Smeg Portofino
Door	With frame	Handle Colour	Brushed stainless steel
Upstand	Yes	Glass type	Grey
Type of pan stands	Cast Iron	Feet	Stainless steel
Hob colour	Stainless steel	Plinth	Black
Command panel finish	Stainless steel	Storage compartment	Push pull
Control knobs	Smeg Portofino	Logo	Assembled st/steel
Controls colour	Stainless steel	Logo position	Facia below the oven
Display	Touch	Alternative colours available	Anthracite, Black, White, Red, Olive green, Yellow, Orange

Hob technical features

Total no. of cook zones 5

Type of gas burners	Standard	Gas safety valves	Yes
Automatic electronic ignition	Yes	Burner caps	Matt black enamelled

Main Oven Technical Features



No. of lights	2	Full glass inner door	Yes
Fan number	3	Removable inner door	Yes
Cavity material	Easy Clean enamel	Total no. of door glasses	3
No. of shelves	5	No. of thermo-reflective door glasses	2
Type of shelves	Metal racks	Safety Thermostat	Yes
Light type	Halogen	Cooling system	Tangential
Light Power	40 W	Usable cavity space dimensions (HxWxD)	371x724x418 mm
Cooking time setting	Start and Stop	Temperature control	Electro-mechanical
Door opening	Flap down	Grill type	Gas
Removable door	Yes	Soft Close system	Yes

Options Main Oven

Timer	Yes	Minimum Temperature	50 °C
End of cooking acoustic alarm	Yes	Maximum temperature	260 °C

Accessories included for Main Oven & Hob



Cast iron wok support	1	20mm deep tray	1
Top oven chrome shelf with back stop	2	Telescopic Guide rails, total Extraction	1
Grill mesh	1		

Electrical Connection

Plug	(B) USA 120V	Frequency	60 Hz
Nominal power	200 W	Power supply cable length	120 cm
Current	2 A	Terminal block	3 poles
Voltage	120 V		

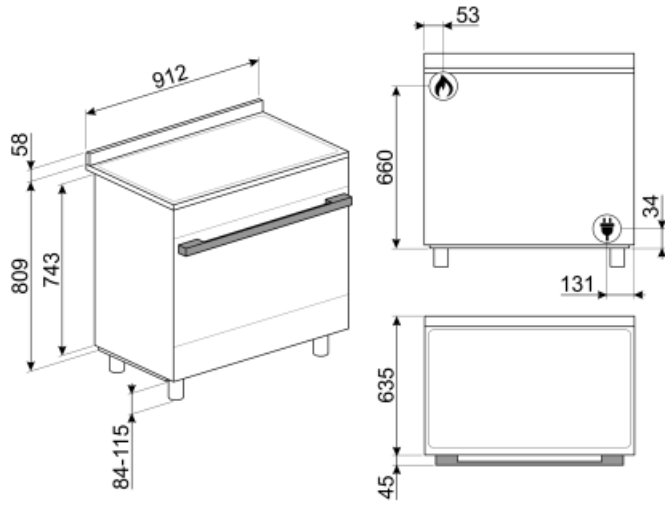

Not included accessories



PAL2

Paletta pizza larga con doppio manico.



SFLK1



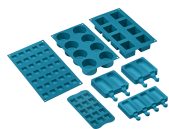











Child lock



SMOLD

Set of 7 silicone moulds for ice creams, ice lollies, pralines, ice cubes or to portion food. Usable from -60°C to +230°C

Symbols glossary

 <p>Heavy duty cast iron pan stands: for maximum stability and strength.</p>	 <p>Air cooling system: to ensure a safe surface temperatures.</p>
 <p>Defrost by time: with this function the time of thawing of foods are determined automatically.</p>	 <p>Triple glazed doors: Number of glazed doors.</p>
 <p>Enamel interior: The enamel interior of all Smeg ovens have a special antacid lining which helps keep the interior clean by reducing the amount of cooking grease adhering to it.</p>	 <p>Circogas: In gas ovens the fan distributes the heat quickly and evenly throughout the oven cavity, avoiding flavour transfer when cooking a number of different dishes at the same time. In electric ovens this combination completes cooking more quickly of foods that are ready on the surface, but that require more cooking inside, without further browning.</p>
 <p>Lower heating element only: This function is ideal for foods that require extra base temperature without browning, e.g. pastry dishes, pizza. Also suitable for slow cooking of stews and casseroles.</p>	 <p>Grill element: Using of grill gives excellent results when cooking meat of medium and small portions, especially when combined with a rotisserie (where possible). Also ideal for cooking sausages and bacon.</p>
 <p>Gas ovens offer instantaneous heat control, reduced cooking times and the ability to bake at much lower temperatures than electric ovens.</p>	 <p>All glass inner door: All glass inner door, a single flat surface which is simple to keep clean.</p>
 <p>The inner door glass: can be removed with a few quick movements for cleaning.</p>	 <p>Side lights: Two opposing side lights increase visibility inside the oven.</p>
 <p>The oven cavity has 5 different cooking levels.</p>	 <p>Soft close: all models are equipped with advanced function of smooth closing of the door, which allows the device to close smoothly and quietly.</p>
 <p>Telescopic rails: allow you to pull out the dish and check it without having to remove it from the oven entirely.</p>	